

Article number: 20240443610

Description: E+G Telescope-Lear motion bearings GN 2404-43-610

Measures

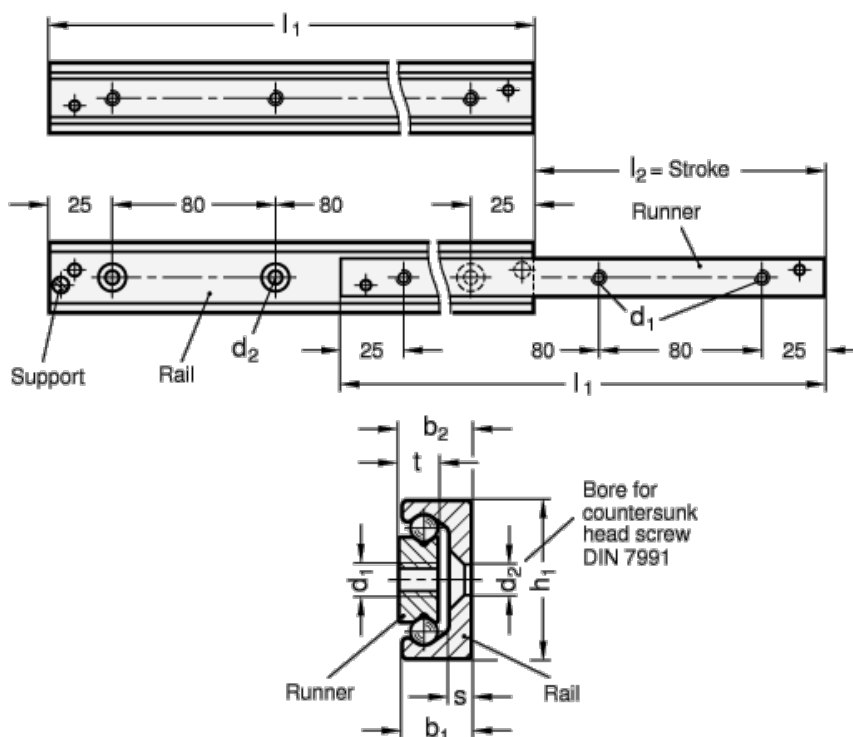

$b_1 = 21$

$b_2 = 22$

$d_1 = M8$

$d_2 = 4.5$

$h_1 = 43$

$L_1 = 313 - 610$

$s = 4.5$

$t = 13.5$

Weight in (g) = 3170